

**This camera manual library is for reference and historical purposes, all rights reserved.**

**This page is copyright by mike@butkus.org M. Butkus, N.J.**

**This page may not be sold or distributed without the expressed  
permission of the producer**

**I have no connection with any camera company**

**If you find this manual useful, how about a donation of \$3 to: M. Butkus, 29 Lake Ave., High Bridge, NJ 08829-1701 and send your E-mail address too so I can thank you. Most other places would charge you \$7.50 for a electronic copy or \$18.00 for a hard to read Xerox copy. These donations allow me to continue to buy new manuals and maintain these pages. It'll make you feel better, won't it?**

**If you use Pay Pal, use the link below. Use the above address for a check, M.O. or cash. Use the E-mail of butkusmi@ptd.net for PayPal.**



**[back to my "Orphancameras" manuals /flash and light meter site](#)**

**Only one "donation" needed per manual, not per multiple section of a manual !**

**The large manuals are split only for easy download size.**

# Canon EOS 700

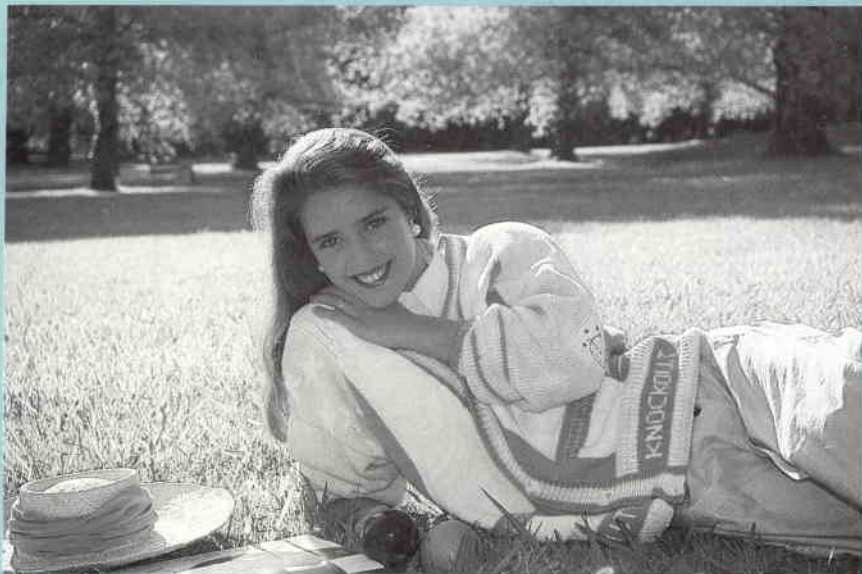

**E**

INSTRUCTIONS

[www.orphancameras.com](http://www.orphancameras.com)

# Introduction

The Canon EOS 700 features high-speed autofocus performance and sophisticated exposure control through the use of new advanced technologies. Incorporating much of the highly acclaimed technology in previous EOS models, this addition to the EOS series is aimed at the photographer who wants simple but flexible operation.

It features "Evaluative Metering," "Depth-of-Field" mode, and eight "Programmed Image Control" settings to make picture taking uncomplicated and provide results that are the envy of others. A revolutionary new *reversible selector dial* allows you to choose from 13 settings to best match your shooting style. The EOS 700 also has a built-in flash that fires automatically without separate batteries. To top it off, the EF 35-80 mm power zoom lens has been specially developed for use with the EOS 700 for unparalleled convenience and ease of use.

All EOS EF lenses are interchangeable, allowing you unlimited views of portraying your subject.

# Attention

## IMPORTANT INFORMATION

The Canon EOS 700 will give optimum performance together with specially designed Canon EF lenses, flash units and other Canon brand accessories. It is possible that the use of incompatible lenses or other accessories may result in unsatisfactory performance or damage to your Canon EOS 700. We therefore suggest the use of Canon EF lenses and accessories. Damage to your Canon EOS 700, as a result of malfunction or improper connections caused by the use of incompatible products may void its warranty.

Please read this instruction book carefully for a thorough understanding before using your EOS 700.

While reading these instructions, unfold the front and back flaps for easy reference to the camera's parts.



# NOMENCLATURE

The camera is shown with the 35-80 mm power zoom lens.

AF Auxiliary Light Emitter

Accessory Shoe

Reversible Selector Dial

Flash

Frame Counter

Flash Switch

Shutter Button

Strap Fixture

Back Cover Latch

Back Cover Lock Button

Lens Release Button

Zooming Buttons  
[TELE] [WIDE]

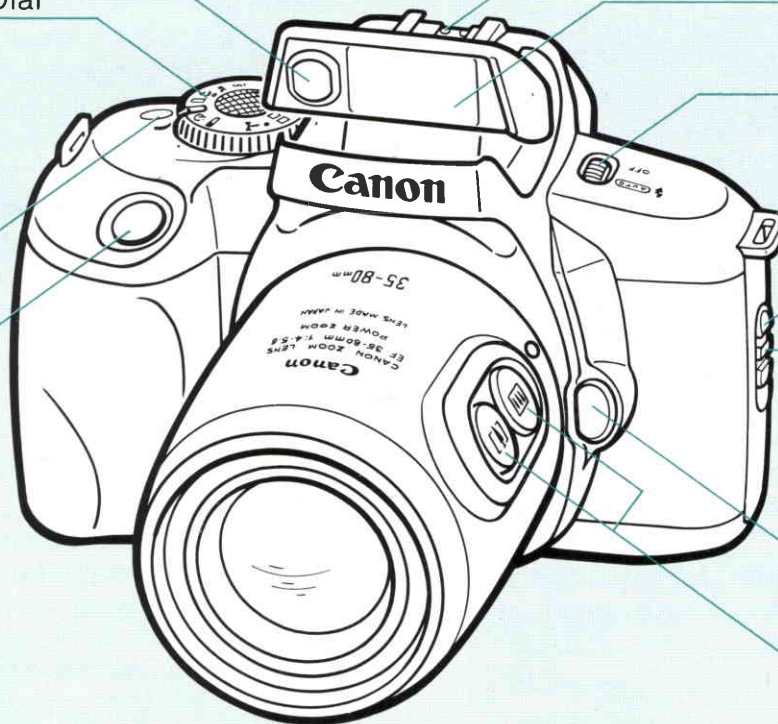

# Table of Contents

## Preparations

1. Lens Attachment	6
2. Loading the Battery	8
3. Checking the Battery	9
4. Reversible Selector Dial	10
5. Viewfinder Information	11
6. Camera Handling	
- Holding the Camera	12
- Shutter Button Action	13
- Using the EF 35-80 mm Power Zoom Lens	14
7. Film Handling	16

## Taking Pictures

1. Program AE	18
2. Composition Tips	20
3. Focus Lock	21
4. Autofocus Considerations	22

## Self-timer Function

	23
--	----

## Flash Photography

	24
--	----

## Programmed Image Control (P.I.C.)

	26
--	----

## Focus Preset Mode

	31
--	----

## Depth-of-Field AE

	32
--	----

## Reversing the Dial Plate

	34
--	----

## Shutter-priority AE

	36
--	----

## “B” Bulb (Long Exposure) Shooting

	37
--	----

## Accessories

	38
--	----

## Reference

	42
--	----

## Caring for Your Camera

	45
--	----

## Specifications

	47
--	----

## 1. Lens Attachment

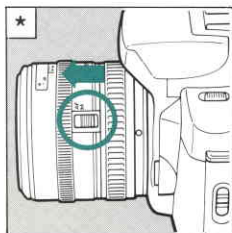
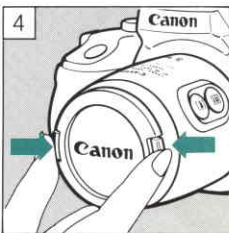
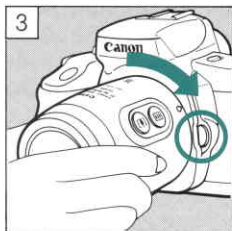
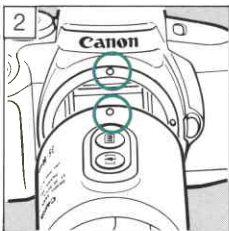
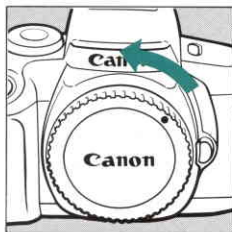
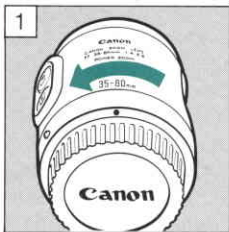

- 1) Remove the rear lens cap and body cap by turning counterclockwise.
- 2) Align the red positioning point on the lens with the camera's "o" mark.
- 3) Turn the lens clockwise until it stops and locks into place with a click.
- 4) Remove the front lens cap.

The EF 35-80 mm power zoom lens is an AF only lens, so *no focus mode switch* is provided.

- \* When using an EF lens other than the EF 35-80 mm power zoom, slide the lens focus mode switch to "AF"
- To remove the lens, press the lens release button while turning the lens counterclockwise.
- To reattach the body cap, align the "o" mark on the cap with the "o" mark on the body and turn clockwise. To reattach the rear lens cap, align the "o" mark on the cap with the red positioning point on the lens and turn clockwise.

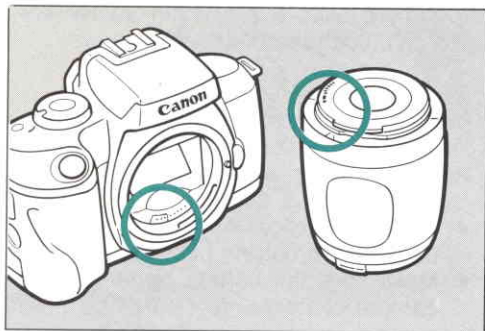

### CAUTION

- When the lens is not attached to the camera, be sure to place the front end of the lens down to avoid damaging the electronic contacts.
- The electronic contacts must be clean for proper contact. Do not touch these contacts.

## 2. Loading the Battery

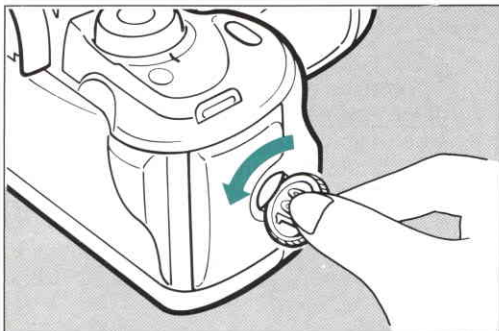

This camera uses a single lithium battery (2CR5, 6V). Load the battery as follows.

- 1) Remove the grip screw with a coin.
- 2) Insert the battery so that its terminals face in the direction shown in the illustration.
- 3) Replace the grip screw securely.

- Be sure to follow the disposal precautions on the battery package.
- Make sure the battery terminals and camera contacts are clean for proper contact.
- See p.43 for other battery information.

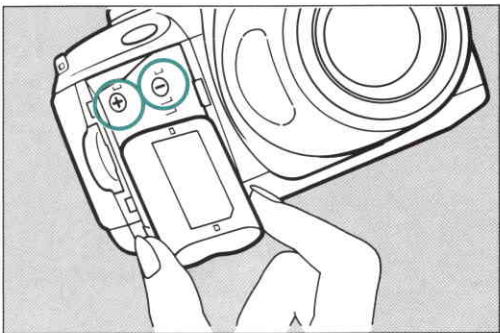



### 3. Checking the Battery

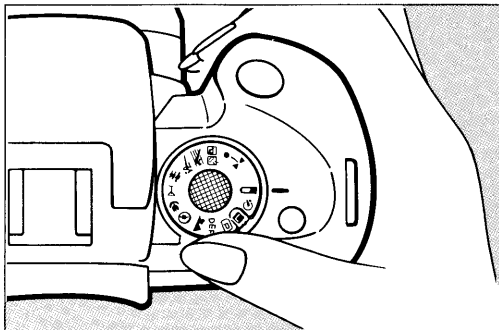

Rotate the dial to “”

Battery power is OK if the beeper tone sounds rapidly (about eight times per second). If it sounds slowly (about two times per second), have a new battery handy. If no tone sounds, replace the battery.

- When you release the dial after checking the battery, the dial returns to the “” (self-timer) position. Turn the dial to the desired position.
- Take a spare battery along to weddings, on trips, or in other situations where you might take a lot of photos.
- See p.42 for shooting capacity.

## 4. Reversible Selector Dial



This dial acts as the camera's control center. It features a reversible dial plate with two sides, A and B. By reversing the dial plate (see page 34), you can change the functions of the camera.

Side A has 14 positions, including a Depth-of-Field AE position, eight Programmed Image Control positions, and a Focus Preset position.





*The reversible selector dial will be referred to as "dial" in this book.*

Side A







-  — Checks battery power. (See p.9)
-  — Self-timer position. Set here for unattended shooting. (See p.23)
-  — Lock (OFF) position. Be sure to set at this position when not in use to prevent accidental shutter release.

 — Program position. The shutter speed and aperture value are automatically set. Set here for basic operation. (See p.18)



- DEP** — Depth-of-Field AE position. For setting the focus zone as desired. (See p.32)
-  — Landscape position. Camera set for shooting landscapes. (See p.26)
-  — Portrait position. Camera set for shooting portraits. (See p.27)
-  — Close-up position. Camera set for shooting close-up pictures of flowers, etc. (See p.27)
-  — Indoor position. Camera set for shooting indoor pictures at parties, etc. (See p.28)

## 5. Viewfinder Information

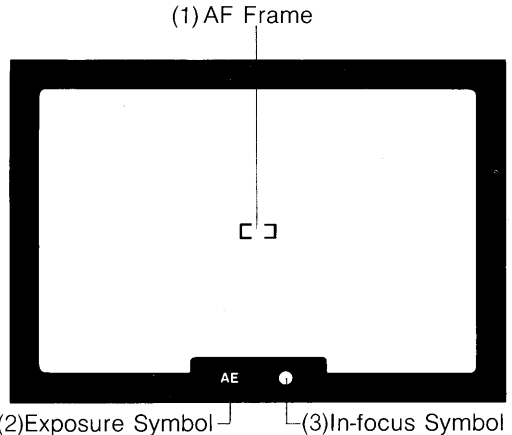
-  — Deep Focus position. Camera set for pictures with a sharp, in-focus background. (See p.28)
-  — Stop Action position. Camera set for shooting sports events. (See p.29)
-  — Flowing position. Camera set for taking “flowing” shots of moving subjects with a blurred background. (See p.29)
-  — Slow Sync/Fill-in Flash position. Camera set for taking slow sync or fill-in flash pictures. (See p.30)
-  — Focus Preset position. For presetting the focus at a desired position. (See p.31)



Inside the viewfinder there are three indicators you should be aware of when the shutter button is pressed.

- 1) AF Frame  
  - Place this frame on the subject.
- 2) Exposure Symbol AE
  - Lights when exposure is okay.
- 3) In-focus Symbol 
  - Lights when subject is in focus.

## 6. Camera Handling

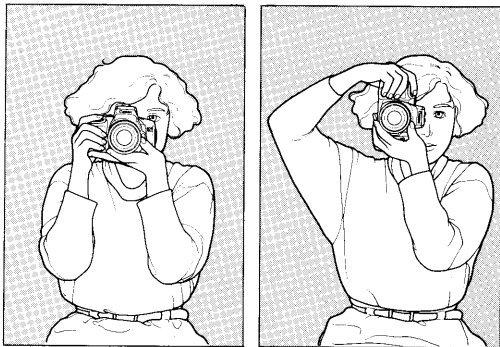

### Holding the Camera

Good pictures require that the camera be held *very still* when the shutter button is pressed. Try this camera-holding technique to avoid disappointments.

- 1) Hold the camera firmly with your left hand supporting both the camera body and the lens.
- 2) Keep your left elbow close to your body.
- 3) Lightly hold the camera against your nose, and look into the viewfinder.
- 4) Spread your feet slightly apart, one foot ahead of the other, and relax.
- 5) If using an EF lens other than the EF 35-80 mm power zoom lens, be careful not to touch the front of the lens during focusing.



Exposure Symbol

In-focus Symbol

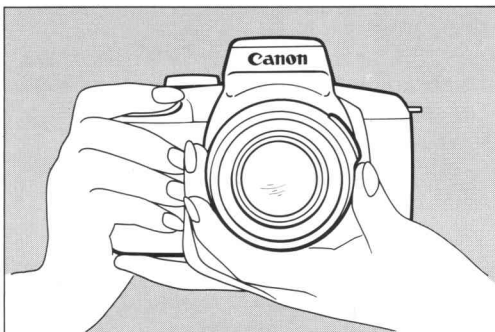

## Shutter Button Action

Pressing the shutter button activates three functions depending on the amount of pressure applied.

- 1) Press halfway for focus and exposure metering. When the subject is in focus the lens stops moving and the in-focus symbol "●" lights steadily.
- 2) Press completely to take the picture.
- 3) Press completely and hold for continuous shooting in Portrait, Stop Action, Flowing, and Shutter-priority AE modes.

- The shutter button cannot be pressed completely if the subject is not in focus (the in-focus symbol "●" blinks).

*Shutter button action plays an important part in taking sharp pictures. A quick stroke with the tip of your finger or fingernail may cause unnecessary camera movement called "camera shake."*

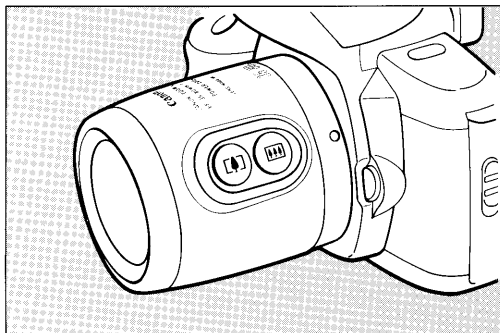

## Using the EF 35-80 mm power zoom lens

This lens is an *autofocus-only*, electrically-driven zoom lens. By simply pressing one of the zooming buttons, you can bring your subject in closer without changing your shooting position.

### Zooming Buttons

When you press [  ], the lens zooms towards the TELE (telephoto: 80 mm) position and the subject comes closer.

When you press [  ], the lens zooms towards the WIDE (wide-angle: 35 mm) position and the subject appears farther away.

- The power zooming function is powered by the camera battery, so there is no need for a separate battery for the lens.



35 mm Wide-angle



50 mm Standard



80 mm Telephoto

## 7. Film Handling

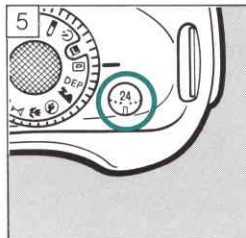
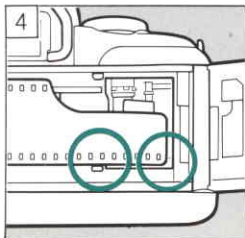
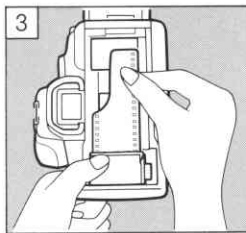
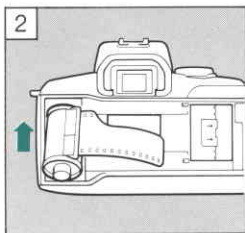
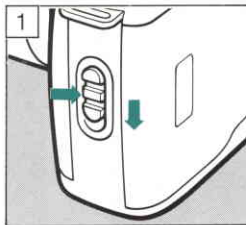
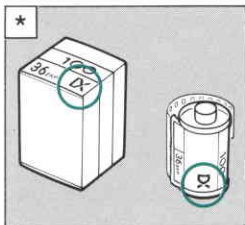

### Loading the Film

A pre-wind film system utilized in this camera immediately winds the film to the end when loaded. During shooting, the frame counter shows the *remaining number of frames* left as the film is rewound into the cartridge.

\*Use only DX-coded 35 mm film. Film without a DX code is set to ISO 25.

- 1) Open the back cover by pushing the latch down while pressing the lock release button.
- 2) Insert the flat end of the cartridge into the top of the film chamber.
- 3) Carefully pull the film tip across until it reaches the orange mark.
- 4) Make sure the film lies flat and that its perforations are properly engaged with the sprocket teeth.
- 5) Close the back cover. The camera immediately advances the film to the end of the roll.



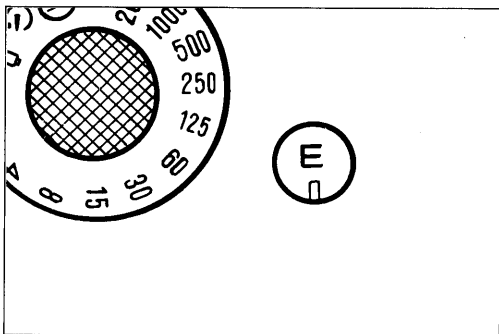

- If "E" appears in the frame counter and a beeper tone sounds, the film has not been loaded correctly. Reload the film. The shutter will not release if the film is not loaded correctly.
- Confirm whether film is loaded or not through the film-load check window.

#### **CAUTION**

- Avoid touching the film sensor contacts.
- NEVER touch the shutter curtain. Its precision design makes it sensitive to pressure.

#### **Removing the Film**

An "E" in the frame counter indicates the roll is finished. Remove the film.

If the film is not removed, a quick beeper tone sounds when the shutter button is pressed.

## 1. Program AE

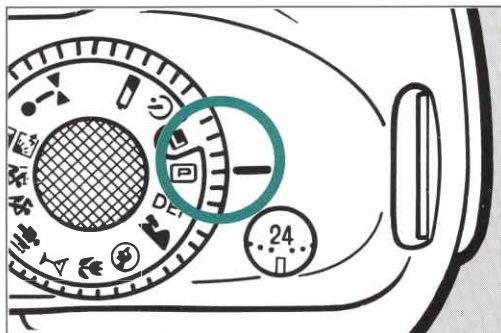

- 1) Set the dial to  Program.
- 2) Look through the viewfinder and place the AF frame on the subject.
- 3) Press the shutter button halfway to focus. When the subject is in focus, the in-focus symbol "●" lights up and a short beeper tone sounds.
- 4) If the flash is set to OFF, make sure the exposure symbol "AE" lights up steadily for good exposure.
- 5) Gently press the shutter button completely to take the picture.

Please be aware of your lens' *closest* focusing distance. If you are too close to the subject, "●" will blink. Step back and repeat #3 until "●" stops blinking.



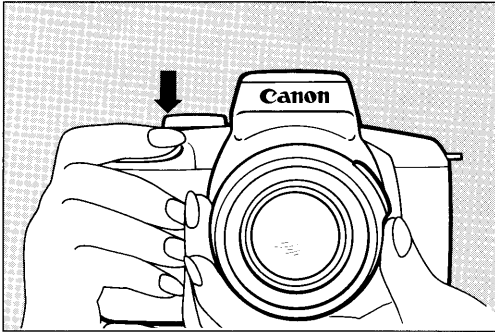

- When focus is impossible, “●” will blink and the shutter will not release. (See p.22)
- If “AE” blinks slowly, about two times per second, this is a camera shake warning. Set the flash switch to AUTO or use a tripod.
- A rapidly blinking “AE”, about eight times per second, warns of incorrect exposure — the lighting is either too bright or too dark. Use a neutral density filter for bright settings or set the flash to AUTO in dark settings.
- The “AE” symbol does not blink when the flash is set to AUTO.

## 2. Composition Tips

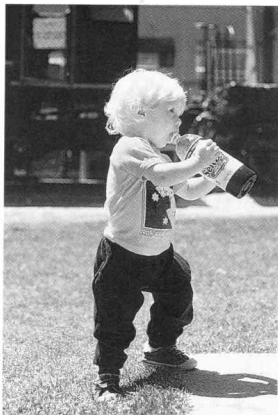

B

Make picture-taking more than just a special occasion affair. Everyday events or just a stroll in the park can be fun to capture on film. The camera's position has a significant influence on the subject's rendition.

- A. Kneel down and shoot from a low angle to heighten action and drama.
- B. Aim from the subject's eye-level when photographing people, especially children.
- C. Watch your position when shooting horizontally, and be sure to include everything in the picture.
- D. Vertical shots emphasize a subject's height and depth.
- E. Move closer to the subject for increased emphasis.
- F. Place the subject off-center to include the background.

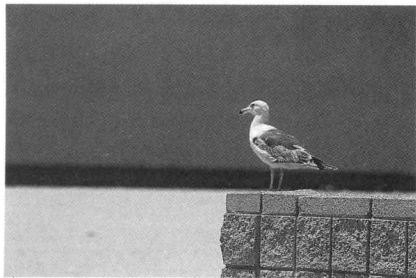

F

### 3. Focus Lock



When your subject is not in the center of the picture frame, use the focus lock function to make sure the intended subject is in focus. Focus on the intended subject remains locked as long as the shutter button is pressed halfway. This function lets you vary composition by putting the subject off-center.

- 1) Put the AF frame on the subject, and press the shutter button halfway to lock the focus.
- 2) Reframe the picture as desired while keeping the shutter button pressed halfway.
- 3) Then, without removing your finger from the shutter button, press completely to take the picture.
  - When using focus lock, be sure that the distance between you and the subject does not change when you reframe the picture.
  - If using a zoom lens, do not change the zoom position after the intended subject is in focus.

## 4. Autofocus Considerations



1

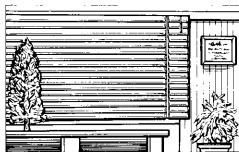

3



4

- 1) Subjects with low contrast (misty scenes, light-colored or white objects).
- 2) Subjects in extremely low-light situations (a dark room, night scenes).
- 3) Subjects having generally horizontal patterns (window blinds).
- 4) Subjects with an object in front of them (caged animals).
- 5) Subjects in extremely strong backlight situations with strong reflections.
- 6) Fast-moving subjects (difficult to keep within the AF frame).

### Focus these subjects as follows:

1. Use the focus lock function on a substitute subject next to the intended subject, and then recompose the picture.
2. Hold the camera vertically and use the focus lock function.

When using the EF 35-80 mm power zoom lens, use the Focus Preset mode. (See p.31)

Although the autofocus system is very accurate, there are some subjects that occasionally present some difficulty.

With these subjects, the autofocus system may not be able to focus, causing “●” to blink rapidly.

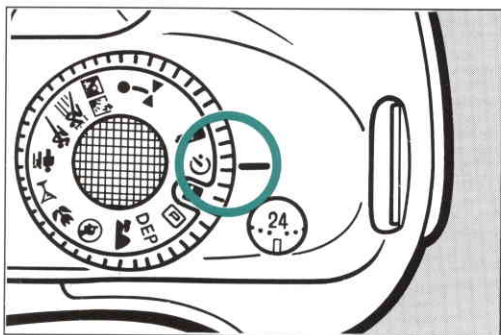

## Self-timer Function

The self-timer function delays the shutter release for 10 seconds to allow you to include yourself in the picture.

- 1) Set the dial to “ 10 ”.
  - 2) Put the AF frame on the subject, and press the shutter button halfway.
  - 3) Make sure the symbols in the viewfinder are not blinking, and while continuing to look through the viewfinder, press the shutter button completely.
- The beeper tone sounds slowly for eight seconds and then rapidly for the final two seconds before the picture is taken.
  - To cancel the self-timer function, set the dial to another position.
  - When using the self-timer, be sure to place the camera on a steady surface or use a tripod.

If you are the subject, put the AF frame on an object located where you will be.

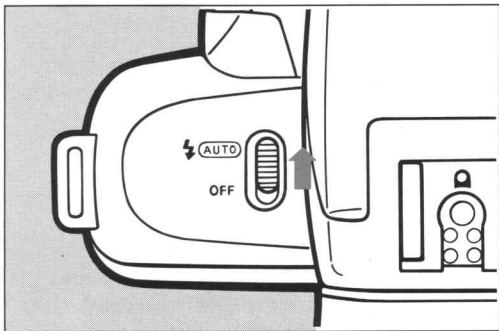

## Flash Photography

The built-in flash features automatic TTL flash control. It operates automatically in low light or when the subject is backlit to supplement insufficient lighting (fill-in flash).

- 1) Slide the flash switch to AUTO.
- 2) Put the AF frame on the subject and press the shutter button halfway. If flash is needed, the flash head pops up automatically.
- 3) Press the shutter button completely to take the picture.

After firing, the flash head retracts automatically.

A subject's eyes may appear red in flash photos due to the light reflected from the retina. To minimize this, have the subject avoid looking directly at the camera. If indoors, turn on additional room lighting.

- The AF auxiliary light automatically emits in extremely dark settings for focus when the flash switch is set to AUTO. The distance range is approximately 3.3 - 13.1 ft/1.0 - 4.0 m.

### **Fill-in Flash Shooting Distance Range:**

Up to approximately 6.6 ft/2 m



## Flash Shooting Distance Range

	EF 35-80mm Power Zoom			
	WIDE: 35mm		TELE: 80mm	
	Color Print Film	Slide Film	Color Print Film	Slide Film
ISO 100	2.3 - 14.1 ft 0.7 - 4.3 m	3.3 - 9.9 ft 1.0 - 3.0 m	2.3 - 9.9 ft 0.7 - 3.0 m	3.3 - 6.9 ft 1.0 - 2.1 m
ISO 400	2.3 - 27.9 ft 0.7 - 8.5 m	4.9 - 19.7 ft 1.5 - 6.0 m	3.3 - 19.7 ft 1.0 - 6.0 m	4.9 - 14.1 ft 1.5 - 4.3 m

200

21.0ft

15 FT

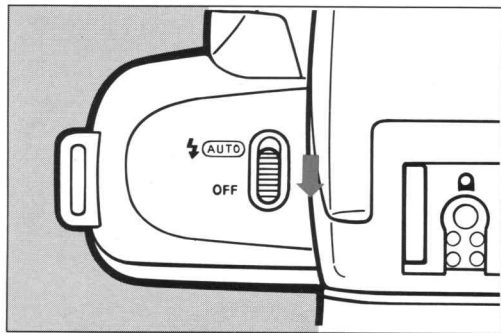

- Set the flash switch to OFF to cancel the flash when you want to take pictures of sunsets, or are in places where use of flash is not allowed (such as in theaters and museums). If the "AE" symbol blinks slowly (two times per second), use a tripod to prevent camera shake.
- *Before using an external flash, be sure that the flash head is down.*



## Programmed Image Control (P.I.C.)

There are eight P.I.C. modes provided on the EOS 700. Each mode is denoted by an illustrative symbol on *side A* of the dial. By simply setting the dial to the appropriate P.I.C. mode, the various settings are automatically programmed to match the picture.



### 1. Landscape

For pictures in which everything from the foreground to the background is reproduced with vividness and clarity.

#### *Hint*

Use a wide-angle lens or the wide-angle (35 mm) setting of the EF 35-80 mm power zoom lens to obtain maximum depth of focus and a wide field of view.



## 2. Portrait

For flattering portraits in which the subject is isolated from the background. Use this mode when you wish to blur the background while keeping the subject in focus.

*Hint*

Use a telephoto lens or the telephoto (80 mm) setting of the EF 35-80 mm power zoom lens. For effective portraits, move in as close as possible to fill the frame with the subject's upper body, focus on the subject's eyes, and keep a wide distance between the subject and the background.

## 3. Close-up

Close-up photos of flowers, insects, and subject detail are easy at this setting. Moving in close provides a different and interesting perspective of ordinary subjects.

*Hint*

Be aware of your lens' closest focusing distance for sharp photos. With the EF 35-80 mm power zoom lens, you can move in as close as 1.6 ft/50 cm, at which point the telephoto (80 mm) setting fills the frame with an area of 136 × 203 mm.



8"

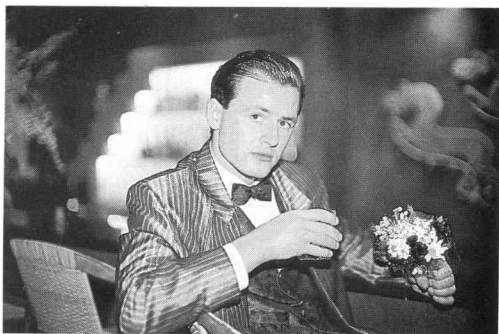

#### 4. Indoor

For group shots and pictures of people when indoors such as at a party or wedding. Be sure to keep within the flash shooting distance range for proper coverage (see p.24).

#### 5. Deep Focus

Use this mode to keep everything from the foreground to the background in sharp focus. This mode is effective for taking snapshots of people keeping the background landscape in focus.

##### *Hint*

If you use the wide-angle setting of the EF 35-80 mm power zoom lens outdoors on a bright, clear day, everything within a distance of approximately 3.3 ft/1.0 meter to infinity will be kept in sharp focus.

For maximum effect, use a wide-angle lens with a focal length of 28 mm or less in outdoor daylight situations.





## 6. Stop Action

Use this mode to freeze the action of a moving subject such as at sports events or when taking pictures of children or pets. This mode is programmed to set the shutter speed as fast as possible for maximum sharpness.

## 7. Flowing

Use this mode when you wish to keep a moving subject sharp while blurring the background to create a feeling of movement. In this mode, the shutter speed is fixed at 1/30 sec.

### *Hint*

Smoothly move the camera to keep the moving subject covered by the AF frame and keep the camera moving while you press the shutter button.

The flowing effect differs according to factors such as shooting distance, lens' field of view, camera-subject angle, and subject movement speed. Try different types of flowing shots to get a feel for various effects.

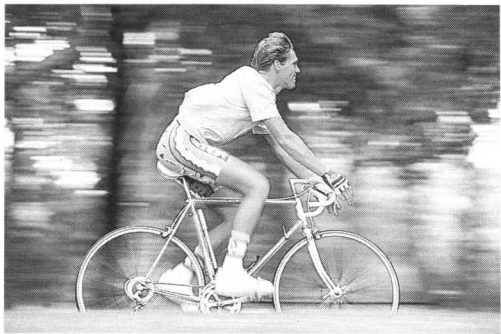



Fill-in

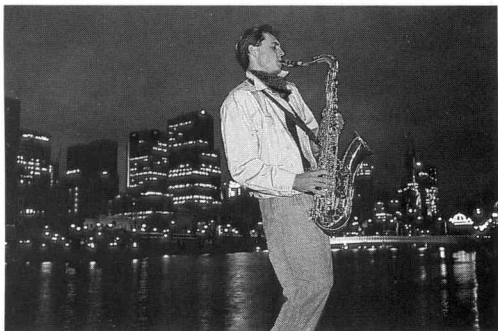

Slow Sync.

## 8. Slow Sync/Fill-in Flash

In this mode, the flash fires while the shutter speed and aperture are set for the ambient lighting level, allowing you to subdue harsh shadows in bright daylight situations or take night shots where both the foreground subject and background are properly exposed.

### *Hint*

Outdoors, use this mode to eliminate harsh, unwanted shadows or to take flattering pictures of people in which the sun is positioned behind the subject for a silhouette. In indoor or nighttime situations, use this mode to take “slow sync” pictures in which the subject is lit with flash while the background is kept properly exposed. Due to the slow shutter speed set in slow sync shooting, use a tripod to keep the background sharp.

## Focus Preset Mode ●-▶

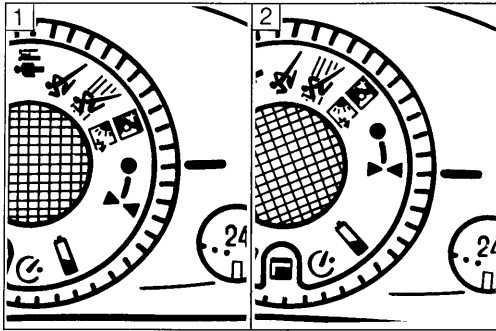

This mode allows you to preset the focus so that the focus distance remains fixed when you remove your finger from the shutter button. Use this mode when you wish to take several pictures from the same focus distance.

- 1) First set the dial to the “●” position, then focus the subject by pressing the shutter button halfway.

- 2) Next, turn the dial to the “▶◀” position to lock the focus. The shutter button can be pressed as many times as desired provided that the focus distance does not change. Be sure the distance between the subject and camera does not change for sharp pictures.

- Although the EF 35-80 mm power zoom lens is not equipped with manual focus, this mode can be used to pre-focus on a subject.
- To cancel this mode, set the dial to another position.

The focus preset mode comes in handy when asking someone to take your picture. Simply give the camera to someone after setting the dial to “▶◀” in step #2. Be sure that the person stands in the same place you were; likewise, you should be at the place where the focus was set. The picture will be sharp even if you are off-center.









- **To cancel this function, set the dial to another position.**
- When focusing extremely near and far points, the automatically-set shutter speed will become comparatively slow, and "AE" may blink slowly to warn of camera shake. If this occurs, use a tripod.
- In step #5, if it is impossible for the camera to get the distance range in focus, "●" blinks quickly (four times per second). Exposure, however, will still be okay.
- *When using a zoom lens, do not change the zoom position after the first point is focused.*

#### **Depth-of-Field AE Hints**

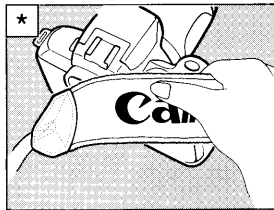
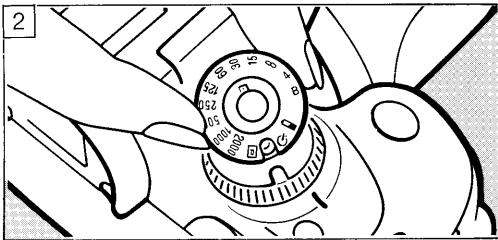
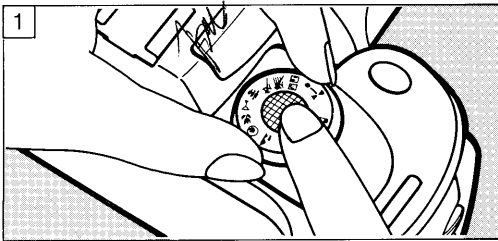
- Use the wide-angle setting of your zoom lens to obtain maximum zone of focus.
- A shallow zone of focus can be obtained by focusing the two points at the same point. The telephoto setting of your zoom lens is recommended for portraits.



## Reversing the Dial Plate

By reversing the dial plate with the B side facing up, you can operate the camera in Shutter-priority AE, "B" Bulb (long exposure) mode, or  Program mode, and still have access to the self-timer and battery check functions.

- 1) While holding the outside of the dial as shown in the illustration, use the ball of your finger to loosen the dial screw by turning it counterclockwise. Remove the screw.
- 2) Turn the dial plate over and place it back so it aligns with the groove. Replace and tighten the screw by turning clockwise.

\*If the dial screw is difficult to loosen, use the cloth part of the strap to loosen the screw as illustrated.



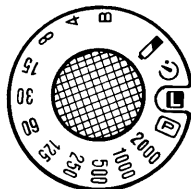

- After reversing the dial plate, be sure to tighten the screw securely to ensure proper camera operation.

## Reversible Selector Dial (Side B)

Side B



Side B has 15 positions, including a Bulb (long exposure) position and ten Shutter-priority AE positions. Both sides have the following positions: battery check, self-timer, lock, and Program Shooting **P**.

-  — Battery Check position. (Same as Side A.)
-  — Self-timer position. (Same as Side A.)
-  — Lock (OFF) position. (Same as Side A.)
-  — Program position. (Same as Side A.)
- 4-2000 — Shutter-priority AE positions. You set the shutter speed and the camera sets the aperture value. (See p.36)
- B — Bulb position. For taking long exposures of night scenes, etc. (See p.37)

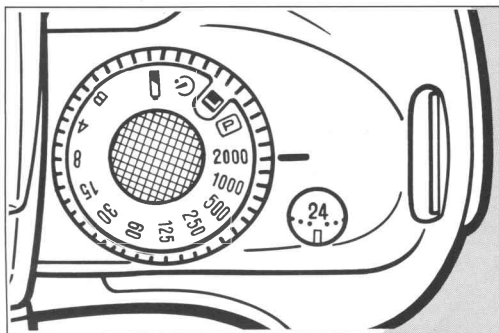

## Shutter-priority AE

In this mode, the user sets the shutter speed and the camera automatically chooses the correct aperture for the lighting conditions. This mode is best for full control over the shutter speed with moving subjects. Faster shutter speeds freeze subject motion while slower shutter speeds can produce artistic blur effects.

To use the camera in shutter-priority AE, set the dial (side B) to the desired shutter speed.

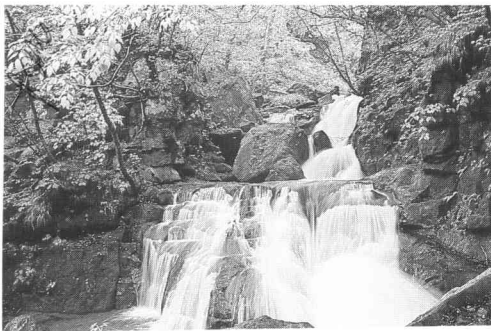

- The numbers “125”, “250”, etc. on the dial indicate shutter speeds of 1/125 second, 1/250 second, etc.
- In general, use a shutter speed equal to or faster than “1/lens focal length” to prevent camera shake. For example, when using the EF 35-80 mm power zoom lens at the 50 mm position, use a shutter speed of 1/60 second or faster. For slower shutter speeds, use a tripod.
- If the flash switch is set to AUTO, the shutter speed will be set to 1/125 second and the flash will fire each time the shutter button is pressed in shutter-priority AE. If flash is not desired, set the flash switch to OFF.



## “B” Bulb (Long Exposure) Shooting

In Bulb mode, the shutter remains open for as long as the shutter button is pressed. Pictures suited for this mode include fireworks displays, car lights at night, and night scenes of city lights.

When shooting in Bulb mode, the aperture remains fixed at f/5.6.

- The picture will be blurred if the camera moves even slightly during a long exposure, so *use a tripod to secure the camera.*
- If the flash switch is set to AUTO, the flash will fire each time the shutter button is pressed in Bulb mode. If flash is not desired, set the flash switch to OFF.

# Accessories

## EF LENS LINEUP

The greatest feature of EOS autofocus cameras is that they accept a variety of interchangeable lenses ranging from fish-eye to telephoto. Canon makes an assortment of interchangeable lenses with high resolution, superb color balance, and easy handling.

Lens	Construction	Minimum Aperture	Closest Focusing Distance		Filter Size (mm)	Length		Weight	
			(ft.)	(m)		(in.)	(mm)	(oz.)	(g)
Fish-eye EF 15mm f/2.8	7-8	22	0.7	0.2	Filter Holder	2-7/16	62.2	11.6	330
EF 24mm f/2.8	10-10	22	0.8	0.25	58	1-15/16	48.5	9.5	270
EF 28mm f/2.8	5-5	22	1	0.3	52	1-11/16	42.5	6.5	185
EF 50mm f/1.8	5-6	22	1.5	0.45	52	1-11/16	42.5	6.7	190
EF 50mm f/1.0L (Ultrasonic)	9-11	16	2	0.6	72	3-3/16	81.5	2.2 lb.	985
Compact-Macro EF 50mm f/2.5	8-9	32	0.748	0.228	52	2-1/2	63	9.9	280
EF 85mm f/1.2L (Ultrasonic)	7-8	16	3.1	0.95	72	3-5/16	84	2.3 lb.	1,025
Macro EF 100mm f/2.8*	9-10	32	1.02	0.31	52	4-1/8	105.5	22.9	650
Softfocus EF 135mm f/2.8	6-7	32	4.3	1.3	52	3-7/8	98.4	13.8	390
EF 200mm f/1.8L (Ultrasonic)	10-12	22	8.2	2.5	48 (drop-in type)	8-3/16	208	6.6 lb.	3,000
EF 300mm f/2.8L (Ultrasonic)	7-9	32	9.8	3	48 (drop-in type)	9-9/16	253	6.3 lb.	2,855
EF 600mm f/4L (Ultrasonic)	8-9	32	19.7	6	48 (drop-in type)	17-15/16	456	13.2 lb.	6,000
EF 20-35mm f/2.8L	12-15	22	1.6	0.5	72	3-1/2	89	19.1	540
EF 28-70mm f/3.5-4.5II	9-10	22-29	1.3	0.39	52	3	75.6	10.1	285
EF 28-80mm f/2.8-4L (Ultrasonic)	11-15	22	1.6	0.5	72	4-11/16	119.5	2.1 lb.	945
EF 35-70mm f/3.5-4.5	8-9	22-29	1.3	0.39	52	2-1/2	63	8.6	245

## EF LENS LINEUP

Lens	Construction	Minimum Aperture	Closest Focusing Distance		Filter Size (mm)	Length		Weight	
			(ft.)	(m)		(in.)	(mm)	(oz.)	(g)
EF 35-70mm f/3.5-4.5A	8-9	22-29	1.3	0.39	52	2-1/2	63	8.1	230
EF 35-80mm f/4-5.6 Power zoom	7-7	22-32	1.6	0.5	52	2-13/16	72	7.2	205
EF 35-105mm f/3.5-4.5	11-14	22-29	3.1	0.95	58	3-1/4	81.9	14.1	400
EF 35-135mm f/3.5-4.5	12-16	22-29	3.1	0.95	58	3-3/4	94.5	16.8	475
EF 35-135mm f/4-5.6 (Ultrasonic)	12-14	22-32	2.5	0.75	58	3-3/8	86.4	15.0	425
EF 50-200mm f/3.5-4.5	13-16	22-29	3.9	1.2	58	5-3/4	146.4	24.4	690
EF 50-200mm f/3.5-4.5L	14-16	22-29	3.9	1.2	58	5-3/4	145.8	24.5	695
EF 70-210mm f/4	8-11	32	3.9	1.2	58	5-7/16	137.6	21.4	605
EF 70-210mm f/3.5-4.5 (Ultrasonic)*	10-14	27-32	3.9	1.2	58	4-3/4	121.5	19.4	550
EF 80-200mm f/2.8L	13-16	32	5.9	1.8	72	7-5/16	185.7	2.9 lb.	1,330
EF 100-200mm f/4.5A	7-10	32	6.2	1.9	58	5-1/8	130.5	18.4	520
EF 100-300mm f/5.6	9-15	32	4.9	1.5	58	6-9/16	166.8	24.2	685
EF 100-300mm f/5.6L	10-15	32	4.9	1.5	58	6-9/16	166.6	24.5	695
EF 100-300mm f/4.5-5.6 (Ultrasonic)*	10-13	32	4.9	1.5	58	4-3/4	121.5	19.1	540
Extender EF 2 ×	5-7	—	—	—	—	2	50.5	8.5	240
Extender EF 1.4 ×	4-5	—	—	—	—	1-1/16	27.3	7.1	200
Life-Size Converter EF	3-4	—	—	—	—	1-3/8	34.9	5.6	160

- Extender EF 2 × is for exclusive use with EF 200mm f/1.8L and EF 300mm f/2.8L.
- Extender EF 1.4 × is for exclusive use with EF 200mm f/1.8L, EF 300mm f/2.8L and EF 600mm f/4L.
- Life-Size Converter EF is for exclusive use with Compact-Macro EF 50mm f/2.5.
- The Power Zoom and "A" series lenses are autofocus only.
- Asterisk (\*) indicates that these lenses will be available soon.



430 EZ



300EZ

## Speedlites

In addition to the built-in flash, other powerful flash units such as the Speedlites 430EZ and 300EZ can also be used with the EOS 700. The Speedlites 430EZ and 300EZ provide balanced exposure from foreground to background with an automatic zoom that adjusts the coverage angle, and a quick recycle time. With the 430EZ, bounce flash can be carried out and an external power source attached. Since Canon's A(Advanced)-TTL system is used with these flash units, the flash automatically adjusts to provide a balance between the subject and background.

The guide numbers at ISO 100 with the flash zoom at the 35 mm position are 98-ft/30-m for the 430EZ and 82-ft/25-m for the 300EZ.

- Never attach an external flash unit to the EOS 700 while the built-in flash is popped-up. Push the flash head down to return it to its retracted position before attaching an external flash unit.
- When an external flash unit is attached, the built-in flash does not fire.



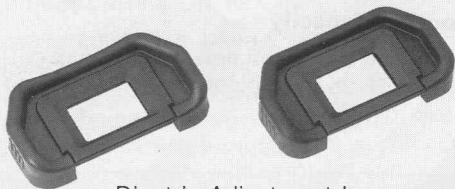

Dioptic Adjustment Lenses

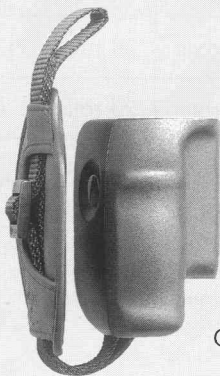

Grip GR 50

### **Dioptic Adjustment Lenses**

Ten eyesight correction lenses are available from +3 to -4 diopters. They make viewing and focusing easier. Choose the one which is closest to your eyeglass prescription.

- The built-in viewfinder eyepiece has a power of -1 diopter.

### **Circular Polarizing Filters PL-C**

To block polarized light, use a Canon Circular Polarizing Filter. They are available in three sizes and screw into the front of the lens. The EF 35-80 power zoom lens accepts a 52 mm filter.

### **Grip GR 50**

For large hands, the Grip GR 50 with an adjustable, padded hand strap makes the camera easy and more comfortable to hold.

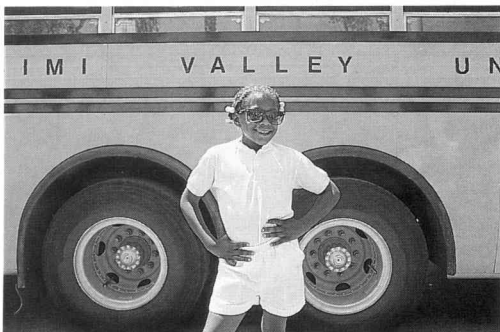

## Reference

### Shooting Capacity

Data based on using a new 2CR5 lithium battery, the EF 35-80 mm power zoom lens, and 24-exp. film.

Temperature Condition	Flash not used	Flash used 50%	Flash used 100%
Normal (68°F/20°C)	65 rolls	35 rolls	13 rolls
Low (14°F/-10°C)	35 rolls	20 rolls	8 rolls

All the data above are based on Canon's Standard Test Method.

## **Battery Information**

### **Lithium Battery Check**

Always check the battery at the following times:

1. When loading a new battery
2. After lengthy storage
3. Before shooting an important event
4. In cold weather
5. If the shutter will not release

## **Battery Use Information**

1. Wipe the battery terminals and the camera contacts with a clean, dry cloth to ensure proper connection.
2. Remove the battery if you do not expect to use the camera for more than three weeks.
3. Battery performance deteriorates slightly in temperatures below 32°F/0°C. If this happens, remove the battery, warm it in the palm of your hands and reload. Keep the camera and especially a spare battery close to your body or in an inside pocket to keep it warm until use.
4. The battery may explode or cause burns if disassembled, recharged, shorted, exposed to high temperatures, or disposed of in fire. Be sure to observe all precautions indicated on the battery package. Always keep it out of the reach of children.
  - See p.9 for battery check instructions.

## Camera Settings For Each Shooting Mode

Various settings such as the AF mode, film transport, and metering are automatically set according to the shooting mode, as shown in the following table.

Side A		Setting combination for each mode						
		AF		Film Transport		Metering		
		One-shot	One-shot/ Servo	Single	Continuous	Evaluative	Center-weighted average	Partial
Program AE			●	●		●		
Depth-of-Field AE		●		●		●		
Landscape		●		●		●		
Portrait		●			●	●		
Close-up		●		●				●
Indoors	Flash off		●	●		●		
	Flash on		●	●		TTL program automatic flash		
Deep Focus		●		●			●	
Stop Action			●		●	●		
Flowing			●		●	●		
Slow Sync/Fill-in Flash		●		●		●		
Focus Preset		●		●		●		
Self-timer		●		●		●		
Side B	Program AE		●	●		●		
	Shutter-priority AE		●		●	●		
	BULB		●	●				
	Self-timer	●		●		●		

## Caring for Your Camera

We recommend cleaning your camera periodically and especially after using it at the beach.

1) To clean the lens surface and the viewfinder eyepiece, blow off dust with a blower brush and gently wipe the lens surface with a lens cleaning tissue slightly moistened with lens cleaner. Clean in a spiral motion from the center outwards.

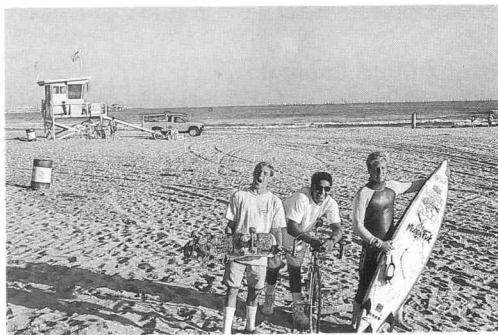

- 2) To clean the reflecting mirror and the focusing screen, only use a blower brush reserved for this purpose. If more cleaning is necessary NEVER attempt to do it yourself; take the camera to an authorized Canon service facility.
- 3) To clean the film chamber, use a blower brush to occasionally remove accumulated film dust particles that might scratch the film.
- 4) To clean the film pressure plate and the film guide rails, lightly wipe the surface with lens cleaning paper moistened with lens cleaning fluid.
  - Be careful NEVER to touch the shutter curtain.
  - Aerosol spray dust removers are not recommended for the shutter curtain area. If used, hold the can at least 8 in/20 cm away from the curtain.

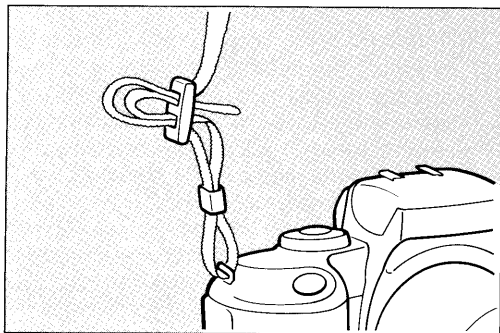

## Strap and Case

### Strap

Thread the ends of the neckstrap through the fixtures as shown.

### Cases (Sold Separately)

Keep the camera in its case to protect it while carrying.

Canon offers three semi-hard cases designed for use with the EOS 700 and 700QD.

- (1) Case S — Body and 50 mm lens
- (2) Case L — Body and 35-80 mm lens
- (3) Case LL — Body and 35-105 mm lens



(1) Case S

(2) Case L

(3) Case LL

- When carrying the camera on your shoulder, keep the lens facing your body to minimize the risk of damage.

# Specifications

## **Type and Major Components**

**Type:** 35 mm focal plane shutter SLR (Single-Lens Reflex) camera with autofocus, auto exposure, built-in flash, and winder.

**Lens Mount:** Canon EF Mount (electronic signal transfer system)

**Usable Lenses:** Canon EF lenses

**Viewfinder:** Fixed eye-level pentaprism. Gives 92% vertical and horizontal coverage of actual picture area and 0.8X magnification with 50 mm lens at infinity.

**Focusing Screen:** New laser-matte screen with AF frame.

**Shutter:** Vertical-travel metal focal plane shutter; all speeds electronically controlled.

**Shutter Speed:** 1/2000-1/4 sec. and bulb in shutter-priority AE.  
1/2000-2 sec. in other modes.  
X-sync is 1/125 sec.

**Mirror:** Quick-return half-mirror

## **Autofocus**

**AF Control System:** TTL-SIR (Secondary Image Registration) phase-detection.

Two modes available: One-shot or auto changeover of One-shot/Servo. Set automatically according to the exposure modes.

**AF Working Range:** EV 1 - 18 at ISO 100

**AF Auxiliary Light:** Built-in AF illuminator operates automatically when required.

## **Exposure Control**

**Light Metering:** TTL full aperture 6-zone metering using SPC PhotoCell). Partial metering used in close-up mode of P.I.C. Center-weighted average metering used in Deep Focus mode of P.I.C.

**Metering Range:** EV 0 - 20 with f/1.4 lens at ISO 100 or equivalent

## **Exposure Modes:**

1. Intelligent Program AE
2. Depth-of-Field AE
3. Programmed Image Control (8 settings)
4. Shutter-priority AE
5. TTL program flash AE (with built-in flash or Speedlite 160 E)
6. A-TTL program flash AE (with Speedlite 430 EZ and 300 EZ)

## **Film Transport**

**Film Speed Setting:** ISO 25-3200; automatically set in 1-step increments according to DX code. No manual setting available. Non DX-coded film set to ISO 25.

**Film Loading:** Automatic pre-wind system.

**Film Wind:** Automatic; single frame or continuous (1.2 frames per second) set automatically according to the exposure modes.

#### **Built-in Flash**

**Guide Number:** 39-ft/12-m at ISO 100

**Recycling Time:** Approx. 2 sec.

**Flash Coverage Angle:** Covers the field of view of 35 mm lens.

**Flash Firing:** Automatic in backlit or low-light condition in AUTO. No firing in OFF mode.

#### **Other**

**Self-Timer:** Electronically controlled with a 10-sec. delay

**Date Imprint (EOS 700QD only):** Four formats available with automatic calendar and clock programmed up to 2019

#### **Power Source**

**Battery:** One, 6 V lithium battery (2CR5) supplies power to body and built-in flash.

**Shooting Capacity:** (with 24-exp. film and EF 35-80 mm Power Zoom lens)

Normal (68°F/20°C): 65 rolls without flash  
35 rolls with 50 % flash use

Low (14°F/-10°C): 35 rolls without flash  
20 rolls with 50 % flash use

#### **Dimensions**

##### **Size:**

EOS 700: 5-7/8" (W) × 4-1/16" (H) × 2-3/4" (D)  
(149.3 × 102.2 × 69.5 mm)

EOS 700QD: 5-7/8" (W) × 4-1/16" (H) × 2-13/16" (D)  
(149.3 × 102.2 × 71 mm)

##### **Weight:**

EOS 700: 1.4 lb. (645 g) with battery

EOS 700QD: 1.4 lb. (655 g) with battery

All data are based on Canon's Standard Test Method.

Subject to change without notice.



## **EF 35-80 mm f/4-5.6 Power Zoom Lens**

### **Field of View:**

Diagonal: 63° - 30°

Vertical: 30° - 17°

Horizontal: 54° - 25°

### **Optical Construction:**

7 elements in 7 groups

### **Maximum Magnification:**

Magnification:  $\frac{35 \text{ mm}}{0.08 \times}$        $\frac{80 \text{ mm}}{0.18 \times}$

### **Closest Shooting Distance:**

1.6 ft/0.5 m

### **Filter Size:**

52 mm

### **Zooming Mechanism:**

Electrically-driven zoom, requires approximately 2 seconds to zoom from WIDE (35 mm) to TELE (80 mm).

### **Dimensions:**

2-11/16" (length) × 2-13/16" (diameter)  
(68 × 72 mm)

### **Weight:**

7.2 oz/205 g

All data are based on Canon's Standard Test Method.

Subject to change without notice.

## Reversible Selector Dial

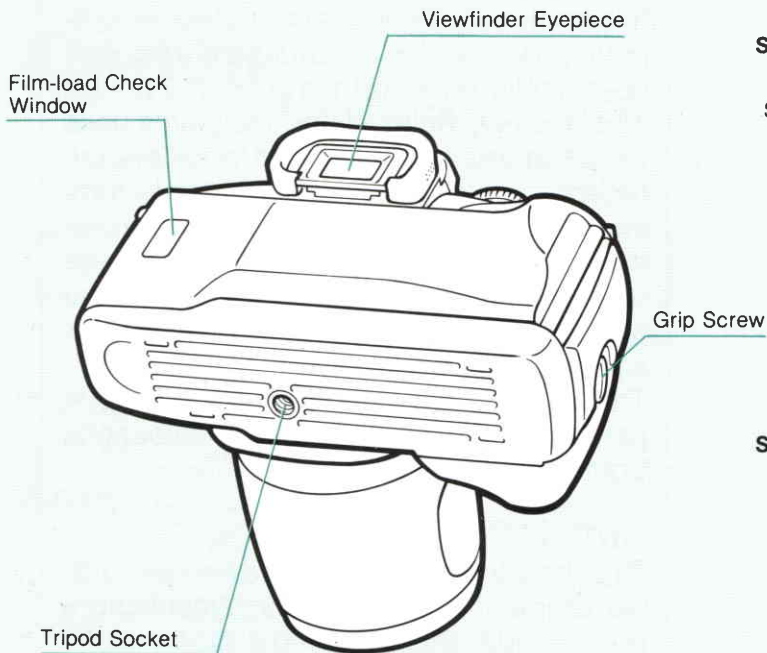

**Side A**

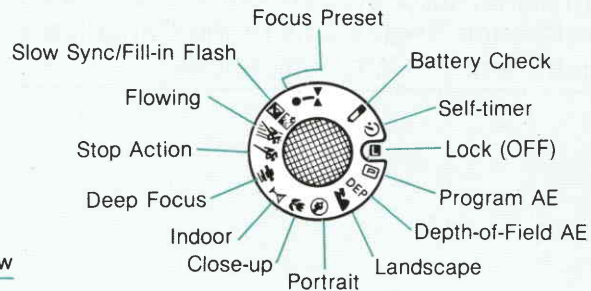

**Side B**

